

A
B
C
D
E
F

A
B
C
D
E
F

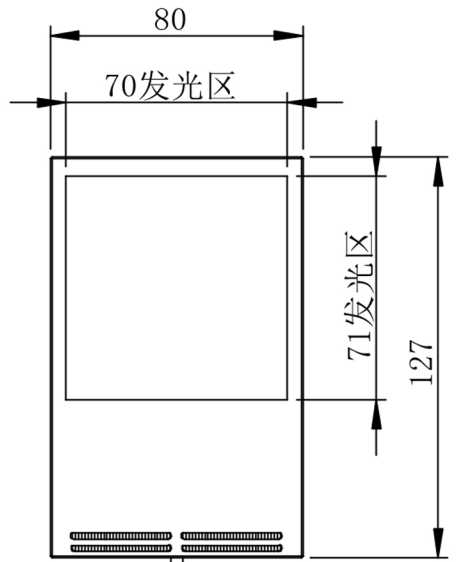
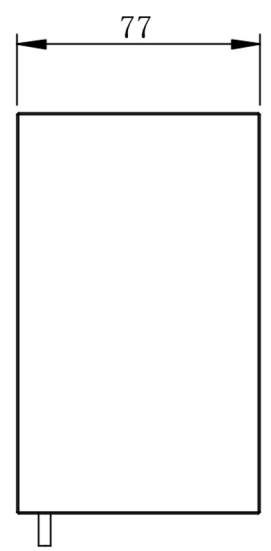
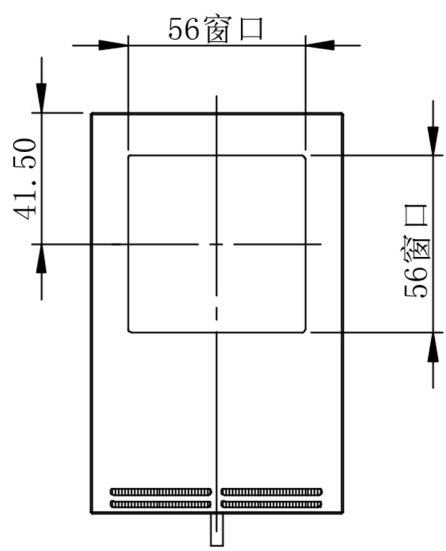
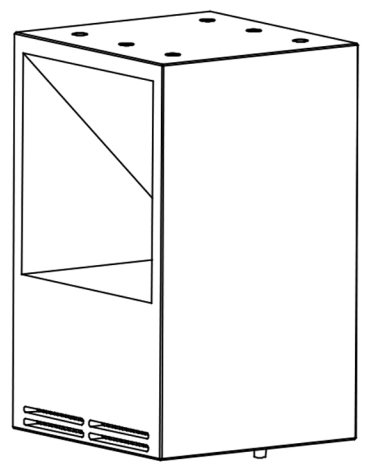
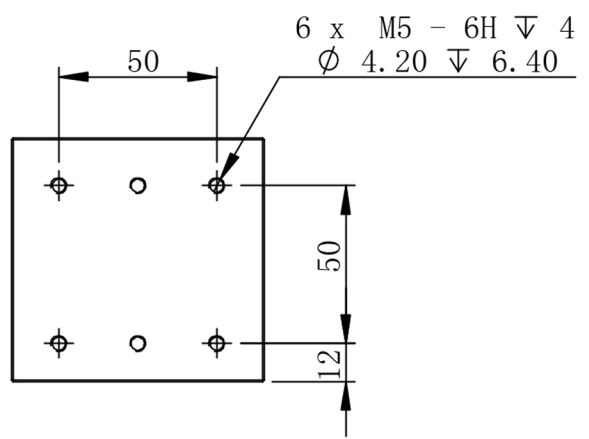

出线长度800mm

Details of Connector

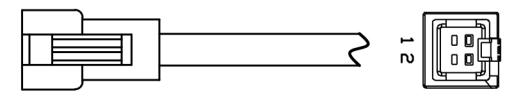

Pin1: - (Blue)
Pin2: + (Red)

Connector Type: SMR-03V-B (Light Side)
SMP-03V-BC (Power Supply Side)

Specification:

MODEL	PL-CO80-W/-B/-G/-UV	-R/-IR850/-IR940
Wavelength (nm)	6500K/470/530/385	625/850/940
Power Supply	DC24V/12.6 (W)	DC24V/8.4 (W)

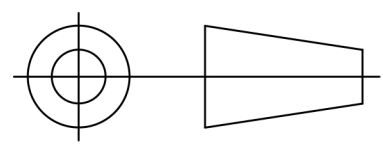

Itemref	Quantity	Material: AL/ACRIL	ArticleNo./Reference
			Filename PL-CO80
			Scale 1/1
PL-CO80-U			
PL-CO80-0000			Edition VER.1.0
			Sheet 1