

颜色 (COLOUR)	波长/色温
白色 (white)	6500k-7000k
红色 (red)	620-625
绿色 (green)	515-520
蓝色 (blue)	465-470
红外 (infrared)	850/940
紫外 (ultraviolet)	375-380

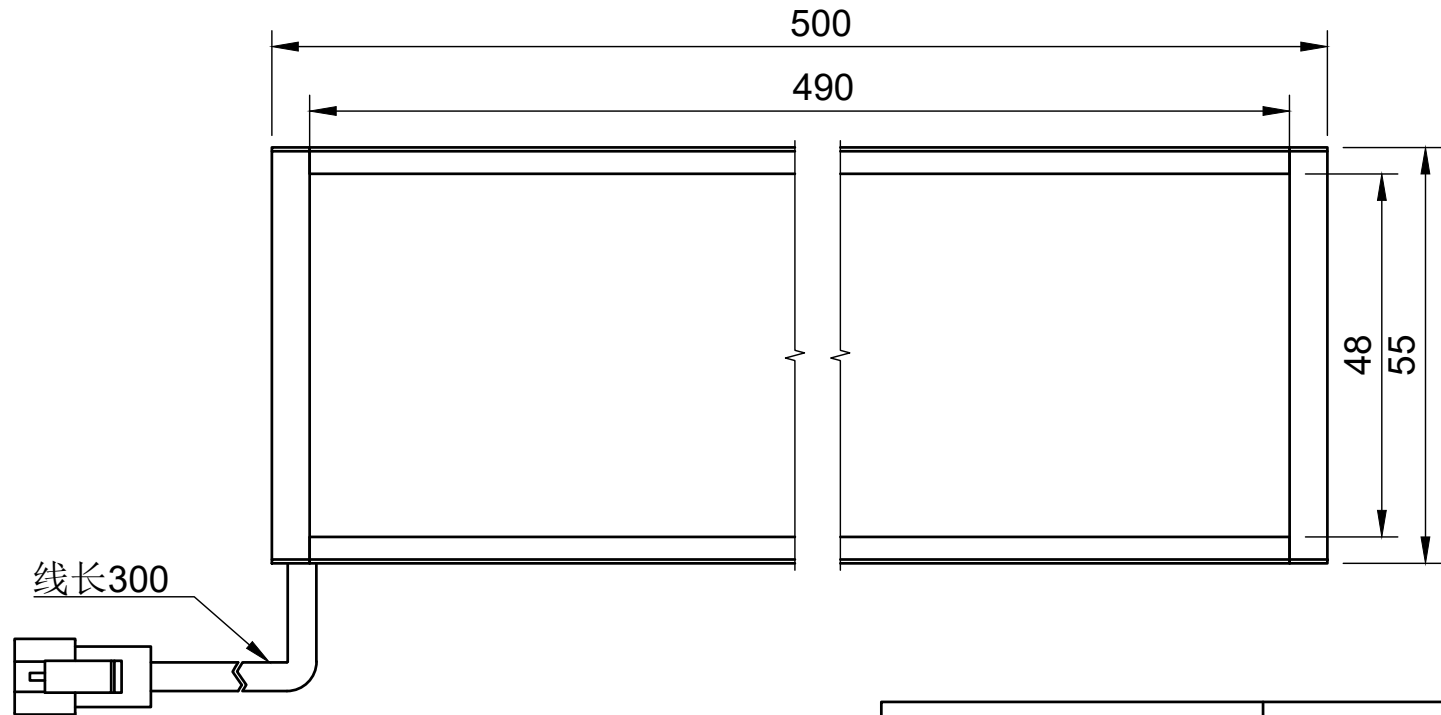
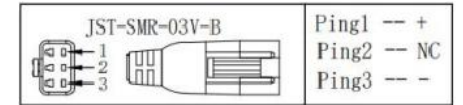
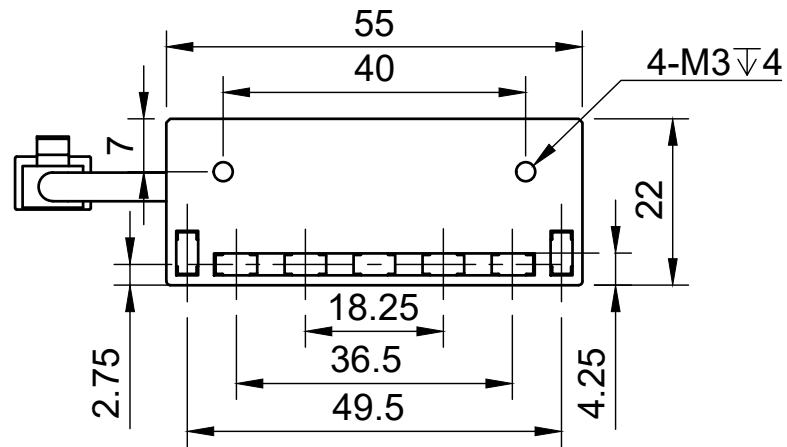

型号:L49055		比例	单位
		1:1	MM
工艺	电压	制图日期	
电镀/阳极	24V	2024/2/21	